



MOMON

LAVABI DA APPOGGIO / Countertop washbasins _ Vasques à poser _ Aufsatzwaschbecken

Finiture _ Finishes _ Finitions _ Afwerkingen

Ceramica lucida
Polished ceramic
Céramique brillante
Keramik poliert



.09

Ceramica opaca
Matt ceramic
Céramique mate
Keramik matt



.17

Ceramica opaca
Matt ceramic
Céramique mate
Keramik matt



.26



MOMON



536982

Vasca ovale da appoggio senza piletta

Oval countertop washbasin without free waste water drain / Vasque ovale à poser sans bonde /

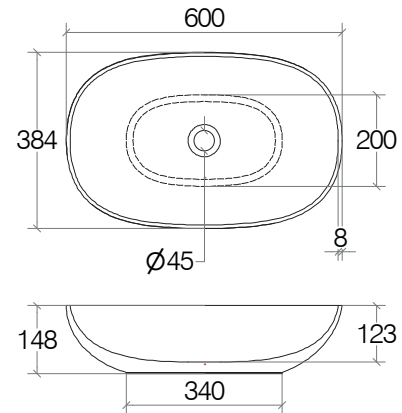
Rundes Aufsatzbecken ohne Ablaufgarnitur



cod. 536982				Ceramica lucida Polished ceramic Céramique brillante Keramik poliert
EAN 8005049355427	9,18	85,8	1	

Peso e volume lordo / Gross weight and volume / Poids et volume brut / Bruttogewicht und Volumen



Made in Italy
Made in Italy
Made in Italy
Made in Italy

PULIZIA e MANUTENZIONE

Pulire con un sapone neutro, applicare con un panno umido, strofinare leggermente, lasciar agire brevemente e quindi sciacquare con acqua. Infine lucidare con un panno morbido e asciutto. Per macchie di calcare pulire con una soluzione di acqua (80%) e aceto bianco (20%), per un'azione igienizzante aggiungere alla soluzione del bicarbonato di sodio. Asciugare sempre la superficie in modo da evitare le macchie derivanti dall'acqua.

Avvertenze: La resistenza alla corrosione al nichel-cromo si riduce sotto l'azione di acidi e composti alogenati (cloruri, bromuri, ioduri). Non utilizzare mai soluzioni a base di cloro (candeggina), detersivi o spugne abrasive. Evitare la ruggine causata da materiali esterni (ad es. paglietta di acciaio ecc.).

CARE and MAINTENANCE

Clean with a mild soap, apply with a damp cloth, rub lightly, leave it briefly and then rinse with water. Finally polish with a soft, dry cloth. To remove the limestone stains, clean with a solution of water (80%) and white vinegar (20%), to sanitize add baking soda. Always dry the surface in order to prevent stains caused by water. Warnings: The corrosion resistance of the steel is reduced by acids and halogen compounds (chlorides, bromides, iodides). Never use solutions containing chlorine (bleach), detergents or abrasive sponges. Prevent rust caused by external materials (eg. Scouring steel, etc.).